

# NEVIS MIRROR

## ASSEMBLY INSTRUCTIONS



### PARTS AND FITTING PACKAGING DETAIL

#### BOX MIRROR

A. MIRROR 1 PC

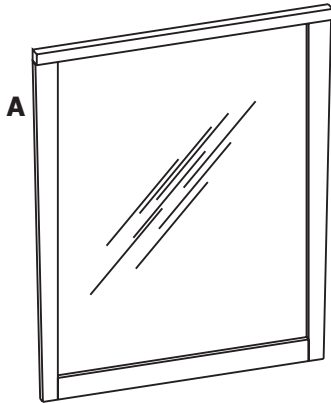

#### BOX DRESSER 7 DRAWER \*

B. DRESSER 7 DRAWER 1 PC  
C. SUPPORT MIRROR 2 PCS  
HARDWARE\*\* IN PLASTIC PUNCH

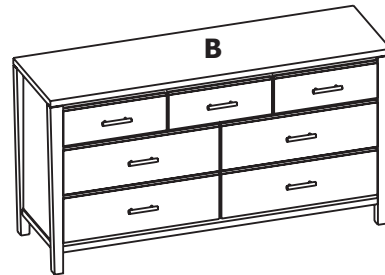

\*SOLD SEPARATELY

#### OPTION 1 FIXING MIRROR ON THE WALL

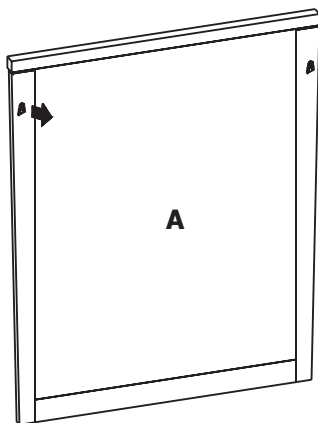

HANGING ON THE WALL  
USING EYE LIDS WHICH  
ALREADY INSTALLED

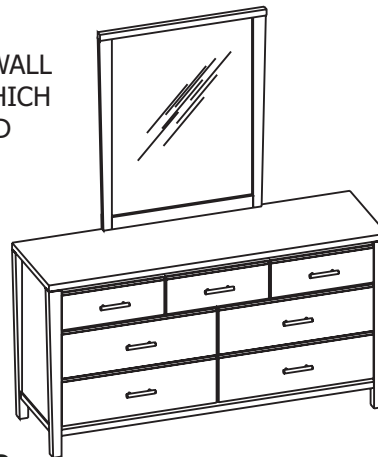

#### OPTION 2 FIXING MIRROR ON THE DRESSER 7 DRAWER

#### HARDWARE\*\* PACKED IN BOX DRESSER 7 DRAWER

1	WOOD SCREWS Ø8X38MM	16 PCS
---	------------------------	-----------

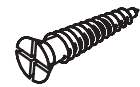

**TOOL REQUIRED :**  
PHILLIPS HEAD SCREW  
DRIVER (NOT PROVIDED)

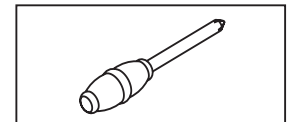

#### STEP 1 :

PLACE SUPPORT MIRROR (C) USING PILOT HOLES ON THE MIRROR AS YOUR GUIDE.

USE PILOT HOLES AS REFERENCE TO CONNECT MIRROR (A) & SUPPORT MIRROR (C) USING WOOD SCREWS (1). TIGHTEN THE SCREWS USING PHILLIPS HEAD SCREW. REPEAT THE STEP FOR SECOND MIRROR SUPPORT.

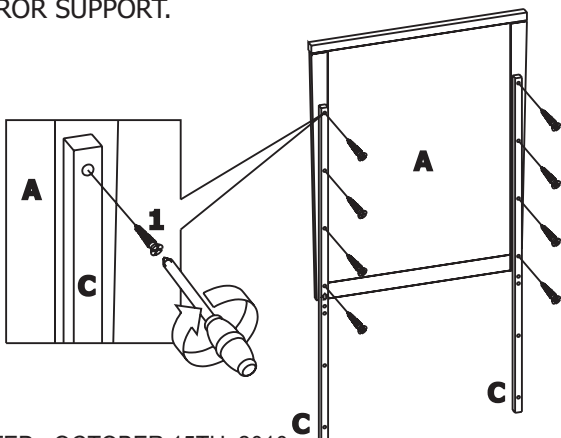

#### STEP 2 :

PLACE SUPPORT MIRROR (C) USING PILOT HOLES ON THE DRESSER AS YOUR GUIDE.

FOLLOW THE ILLUSTRATION TO FIX MIRROR (A) TO DRESSER 7 DRAWER (B) USING WOOD SCREWS (1) ON SUPPORT MIRROR FROM BACK SIDE, USE PILOT SCREWS AS REFERENCE FOR EASY ASSEMBLY. TIGHTEN THE SCREWS USING PHILLIPS HEAD SCREW.

