





MONDRIAN VANITY BENCH ASSEMBLY INSTRUCTIONS

HARDWARE		LIST		
A	BOLT		5/16"*1-1/4"	8PCS
B	WRENCH		5/16"	1PCS
C	FLAT WASHER		5/16"	8PCS
D	SPRING WASHER		5/16"	8PCS



Step1. Place the dressing chair upside down on a soft surface and fasten the feet through the corner block.

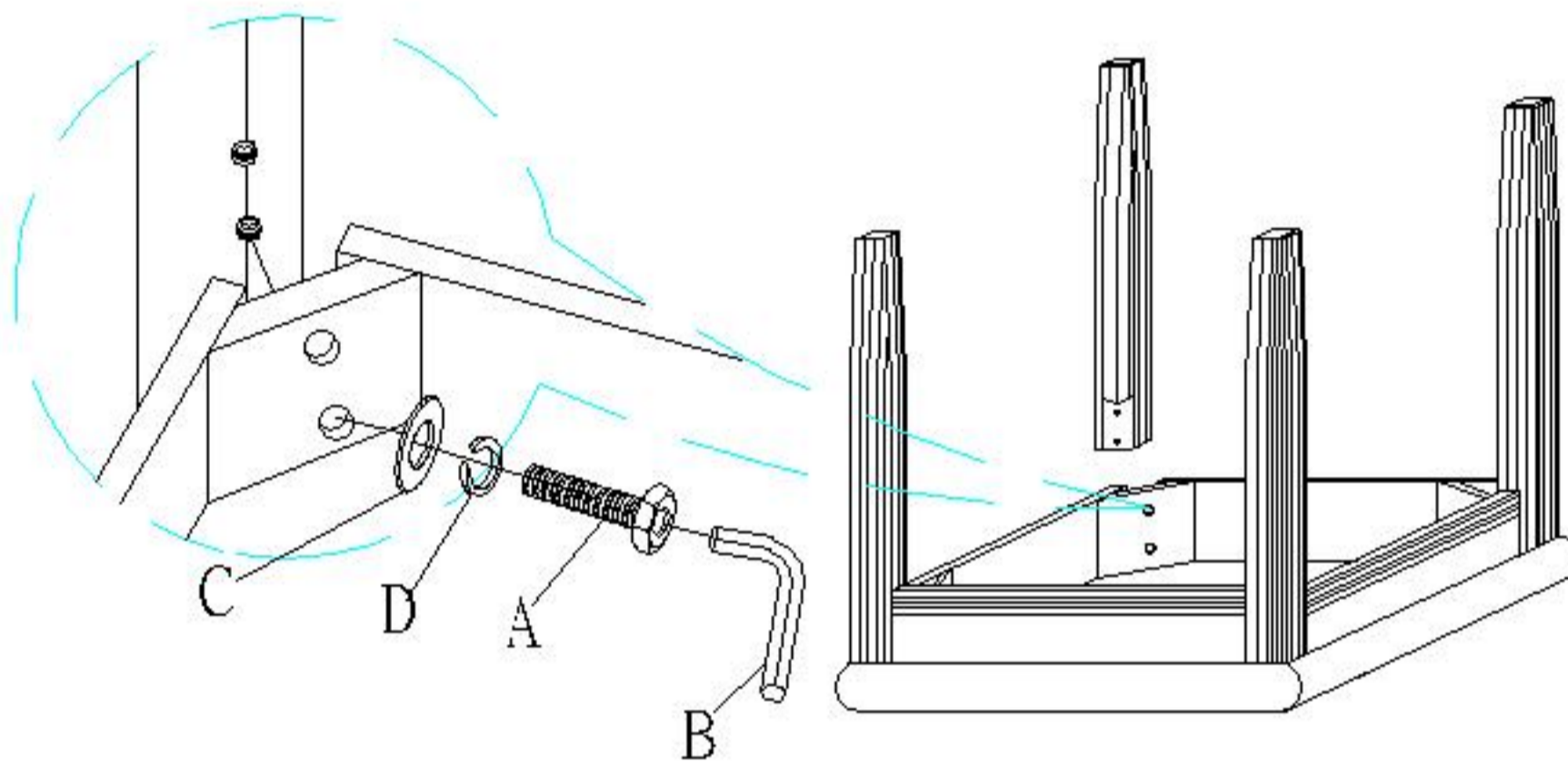
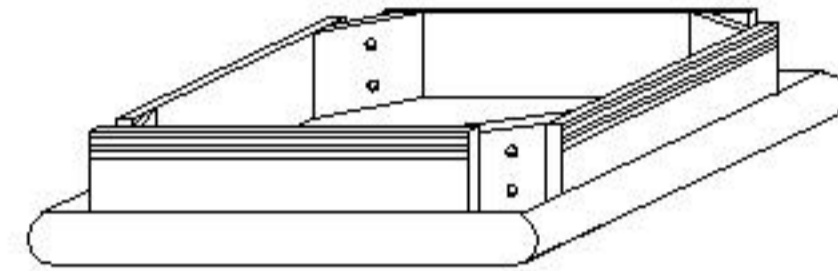
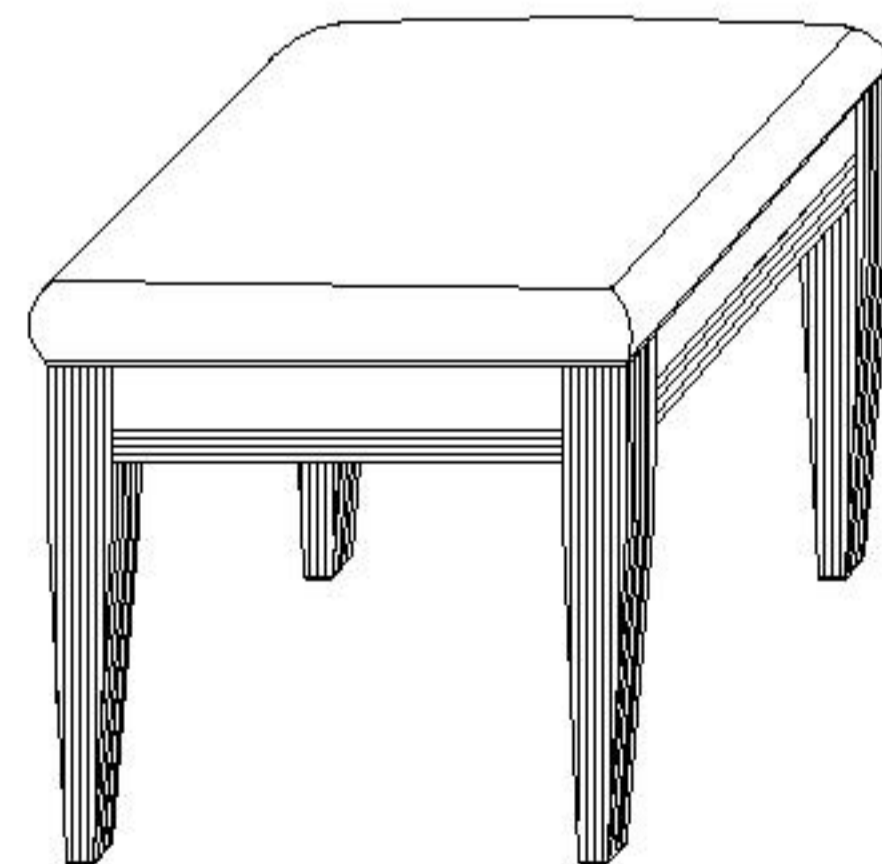
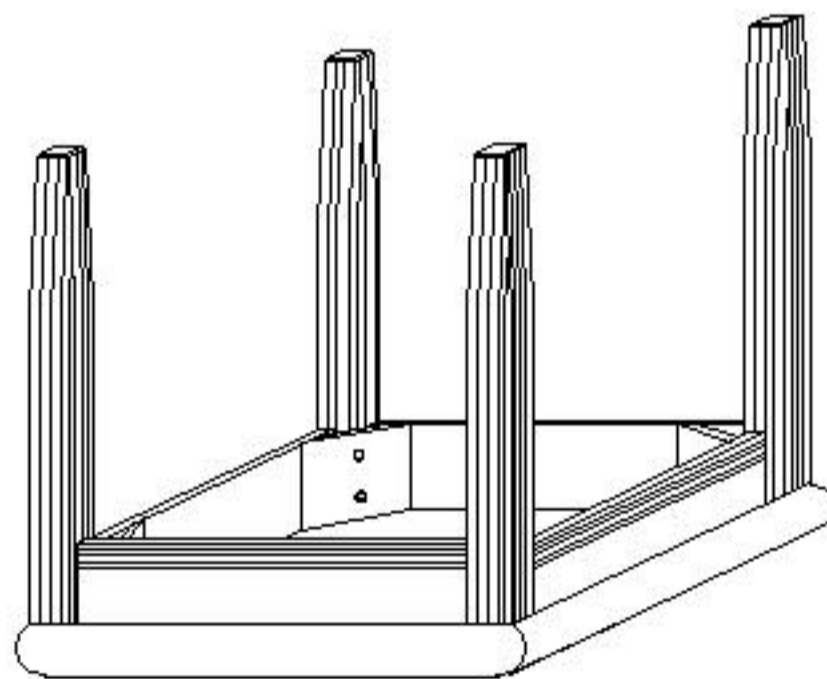

Step2. Turn the chair to upright position