

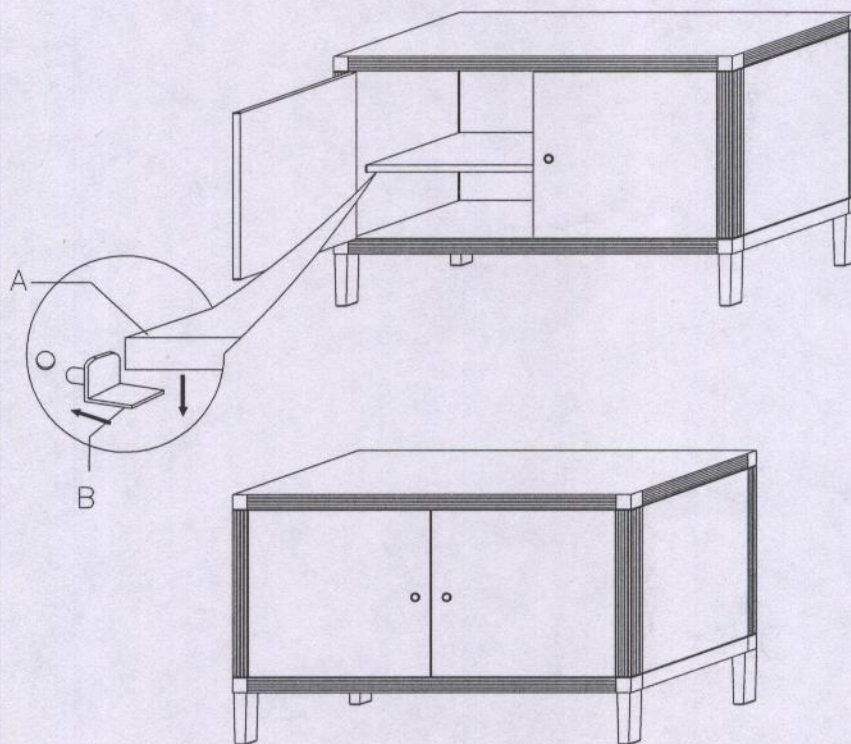

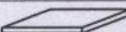





MONDRIAN ARMOIRE HUTCH AND BASE

ASSEMBLY INSTRUCTIONS

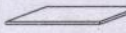

Step1: Insert the shelf latch to the armoire top and attach the adjustable shelf to the shelf latch

HARDWARE		LIST		
A	Shelf			1 PCS
B	Shelf Support Pin			12PCS
C	BOLT		ø1/4"*1"	4 PCS
D	SPRING WASHER		ø1/4"	4 PCS
E	FLAT WASHER		ø1/4"	4 PCS
F	Allen key		ø1/4"	1 PC
G	Ferror layer			2 PCS
H	Shelf		1094*553*19	2 PCS
I	Partition Panel		548*194*16	1 PC
J	Bracket			2 PCS

Step 2

Place the armoire upper on the armoire base

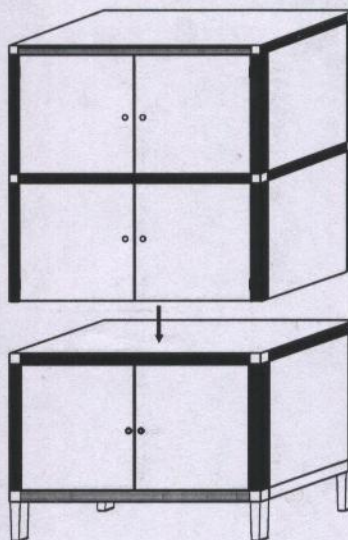

Step 3

Securing armoire upper and base using ferrule layer and screws

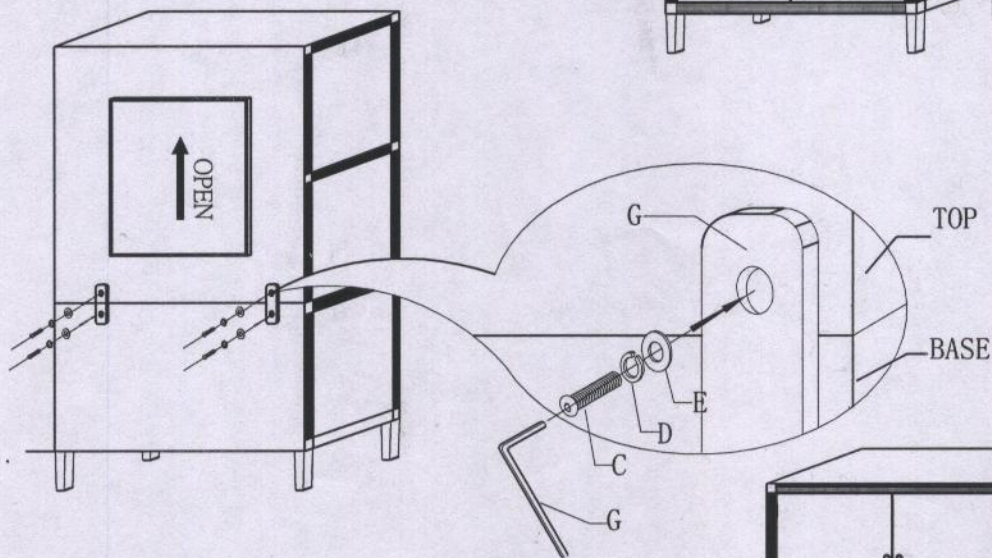

Step 4

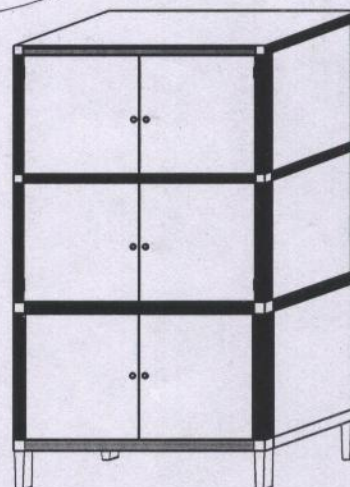

Step 5

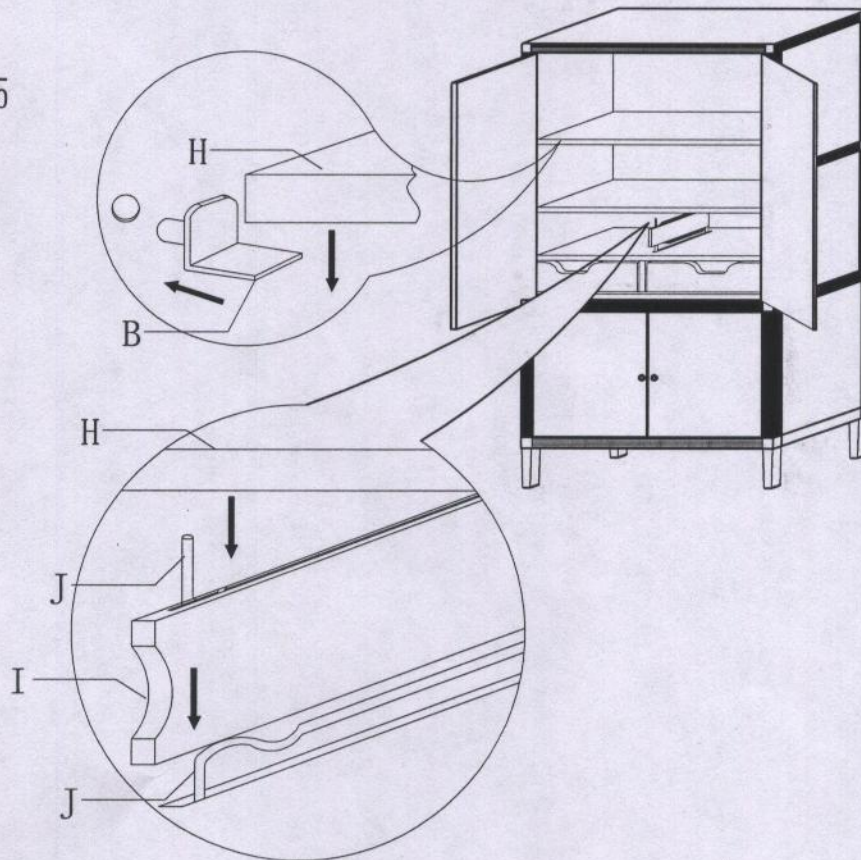

Step 6

